

# Koala 32 AF













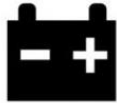

## Refrigerated container for the transport of chilled and frozen products at a controlled temperature

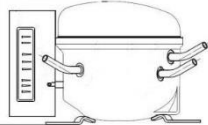
- Available in versions:
  - AF: temperature adjustment range: from -30°C to +10°C;
  - AFH: with heating kit and temperature adjustment range: from -30°C to +40°.
- Insulation offered by container walls (particularly thick), ensures that the temperature maintenance is guaranteed with a minimum number of ignitions of the cooling unit; this contributes limiting energy consumption.
- Easy to transport by car and easy to handle thanks to the dimensions and weight content.
- Cooling unit is triggered when external temperature is higher than the temperature set with the programmable digital thermostat. This allows to maintain a constant temperature even in case of very high external temperatures.
- In the ASH versions, the heating unit is triggered when external temperature is lower than the temperature set with the programmable digital thermostat. This allows to maintain a constant temperature even in case of very low external temperatures.
- Total compliance with the cold chain at all stages of transport.
- It can be transported using conventional vehicles: it allows to simultaneously transport chilled, frozen and ambient temperature products using a single non-insulated vehicle.
- Dual power source: during transport can be connected to the battery (or auxiliary battery) of the vehicle and, at the destination, can be connected to mains power.
- Manufactured using the rotational moulding technology: mono-block container and door (free of sharp edges, joints and welds).
- Fully recyclable at the end of the operating life.

### MANUFACTURING MATERIALS

<b>Polyethylene</b>	inner and outer walls of the container and lid; suitable for food contact	<b>Polyurethane</b>	insulating material between the walls of the container and of the lid; free of CFC and HCFC
<b>Silicone</b>	seal	<b>Stainless steel</b>	handle and closing hooks, grip handles
<b>Aluminum</b>	carter, control panel		

## TECHNICAL CHARACTERISTICS

<p><b>AF version</b></p>	<ul style="list-style-type: none"> <li>• from 0°C to +10°C</li> <li>• from -18°C to +10°C</li> <li>• from -25°C to +10°C</li> <li>• from -30°C to +10°C</li> </ul>	<p><b>AFH version</b></p>	<ul style="list-style-type: none"> <li>• from 0°C to +40°C</li> <li>• from -18°C to +40°C</li> <li>• from -25°C to +40°C</li> <li>• from -30°C to +40°C</li> </ul>
<p><b>+/- 0,5 °C</b></p>	<p>Degree of accuracy in temperature adjustment:</p> <ul style="list-style-type: none"> <li>• +/-0,5 °C.</li> </ul>		<p>Protection against voltage drops of the vehicle battery, in case of falling below of the limit value of <b>11V</b>.</p>
	<p>Equipped with two cables:</p> <ul style="list-style-type: none"> <li>• for power supply to <b>230Vac 50-60Hz</b> .</li> </ul>		<p>For feeding to <b>12/24Vdc</b></p> <ul style="list-style-type: none"> <li>• with fork terminals for connection to the vehicle battery</li> <li>• with cigarette lighter socket (depending on the versions, see table in technical data for more detailed information).</li> </ul>
	<p>Cooling unit performance guaranteed for use at ambient temperature:</p> <ul style="list-style-type: none"> <li>• <b>da+10°C a +30°C.</b></li> </ul>		<p>Container (insulated case) guaranteed for use:</p> <ul style="list-style-type: none"> <li>• <b>from -30° to +100°C.</b></li> </ul>
<p><b>GAS</b></p>	<p>Coolant gas:</p> <ul style="list-style-type: none"> <li>• <b>R134a</b> (version 0°C +10/+40°C; -18°C +10/+40°C; -25°C +10/+40°C)</li> <li>• <b>R452A</b> (version -30°C +10/+40°C).</li> </ul>		<p>Cooling unit equipped with a "roll-bond" static evaporator.</p>
	<p>Adjustment and control of the temperature with programmable digital thermostat.</p>		<p>Hermetic compressor with electronic control unit for adjustment and control equipped with overvoltage protection.</p>
	<p>Hinges integrated in the container.</p>		<p>Adjustable vent valve.</p>
	<p>Stainless steel grip handles integrated into the body.</p>		<p>Practical and resistant closing system.</p>
	<p>Evaporator protection internal grid made of plasticised metal wire.</p>		<p>Monobloc structure, without edges, joints and welding.</p>
	<p>Door seal gasket fixed with stainless steel points.</p>		<p>Stainless steel locking kit available for fixing between them two stacked containers (height 2 KOALA stacked: 980mm).</p>
	<p>Available (on request) USB datalogger to record temperature data during transport.</p>		<p>Insulated with CFC and HCFC-free polyurethane foam.</p>

## TECHNICAL SPECIFICATIONS

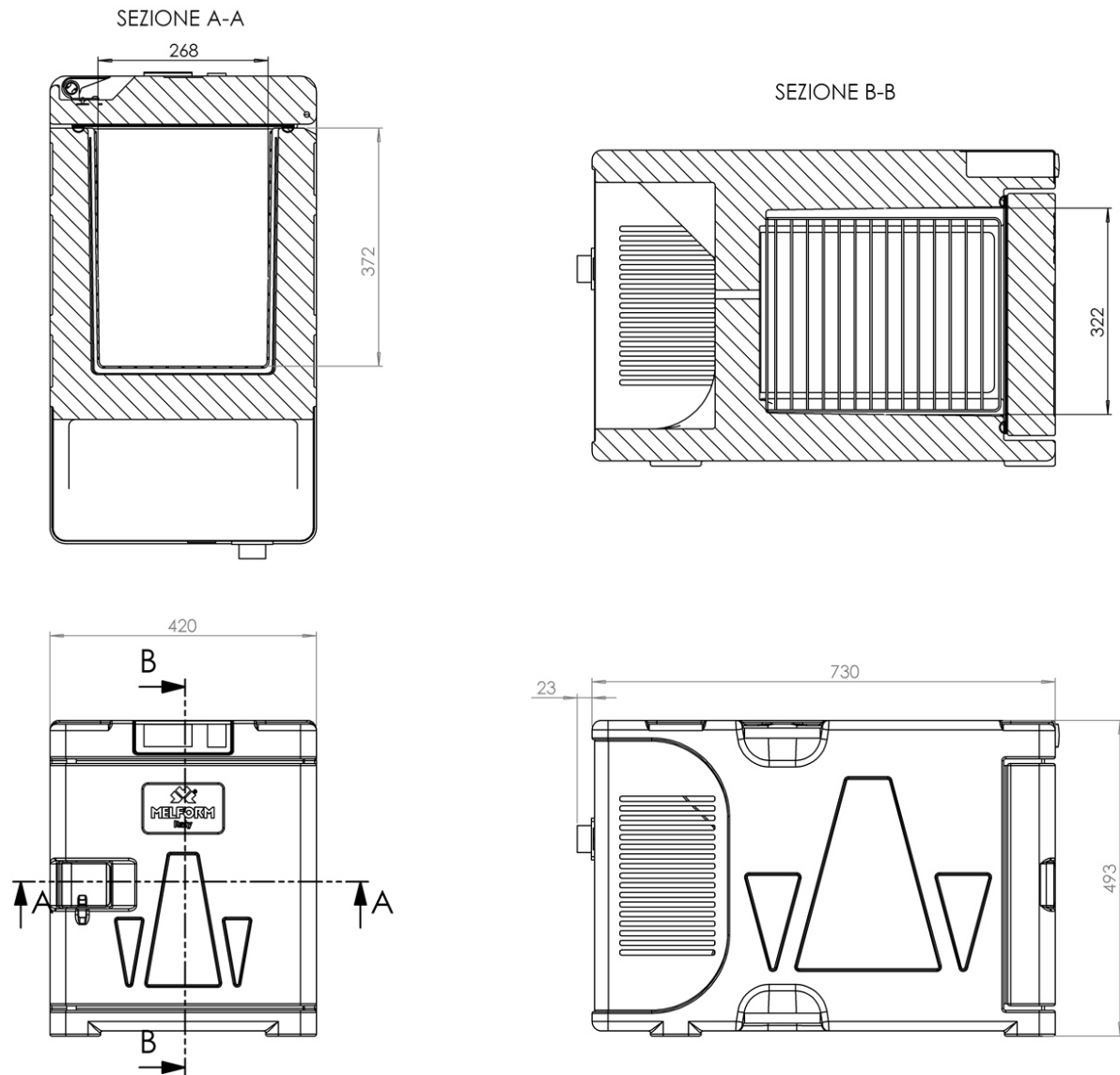

Model	Code	12V Power supply Fork terminal	12/24 V Power supply Cigarette lighter socket	Nominal absorption	Fuses
<b>AF VERSION</b>					
Koala 32 AF from 0°C to +10°C	39AF1021		✓	0,35A to 230Vac 3,5A to 24Vdc 7A to 12Vdc	4A for 230Vac 15A for 12/24Vdc
Koala 32 AF from -18°C to +10°C	39AF1020	✓		0,62A to 230Vac 12A to 12Vdc	4A for 230Vac 25A for 12Vdc
Koala 32 AF from -25°C to +10°C	39AF1022	✓		0,62A to 230Vac 12A to 12Vdc	4A for 230Vac 25A for 12Vdc
Koala 32 AF da -30°C a +10°C	39AF1023	✓		1A to 230Vac 18A to 12Vdc	4A for 230Vac 30A for 12Vdc

Model	Code	12V power supply Fork terminal	12/24 V power supply Cigarette lighter socket	Nominal absorption	Fuses
<b>AFH VERSION AFH (with heating kit)</b>					
Koala 32 AFH from 0°C to +40°C	39AF1015		✓	<b>0,35A</b> to 230Vac <b>7A</b> to 12Vdc	<b>4A</b> for 230Vac <b>15A</b> for 12Vdc
Koala 32 AFH from -18°C to +40°C	39AF1013	✓		<b>0,62A</b> to 230Vac <b>12A</b> to 12Vdc	<b>4A</b> for 230Vac <b>25A</b> for 12Vdc
Koala 32 AFH from -25°C to +40°C	39AF1011	✓		<b>0,62A</b> to 230Vac <b>12A</b> to 12Vdc	<b>4A</b> for 230Vac <b>25A</b> for 12Vdc
Koala 32 AFH from -30°C to +40°C	39AF1012	✓		<b>1A</b> to 230Vac <b>18A</b> to 12Vdc	<b>4A</b> for 230Vac <b>30A</b> for 12Vdc

Model	Code	Colour	External dim. (mm)	Internal dim. (mm)	Capacity l	Weight Kg
Koala 32 AF/AFH		melange grey blue	420x753xh493	268x372xh322	32	30
<b>ACCESSORIES</b>						
Locking kit <b>2 closures</b>	RRI137					1,2

